

Data sheet

2 - way valve for steam, pressure relieved (PN 25) VGS - external thread

Description



VGS is pressure relieved 2-way normally open (NO) valves for steam, designed to be combined with:

- AVT Temperature actuators
- STM Safety temperature monitors
- STL Safety temperature limiters
- AMV(E) 20 / AMV(E) 30 electrical actuators
- AMV(E) 23 / AMV(E) 33 electrical actuators with spring return function

In combination with AVT temperature actuators and AMV(E) electrical actuators, valves can be used for temperature control with steam or hot water up to 200 °C.

Main data:

- DN 15-25
- k_{vs} 1.0-6.3 m³/h
- PN 25
- Temperature:
 - Steam/circ. water/glycolic water up to 30 %: 2 ... 200 °C
- Connections:
 - Ext. thread (weld-on, thread and flange tailpieces)
- Flow and return mounting

Ordering

Example:
Valve for steam, DN 15; k_{vs} 1.6;
PN 25; T_{max} 200 °C; ext. thread

- 1x VGS DN 15 valve
Code No: **065B0787**

Option:

- 1x Weld-on tailpieces
Code No: **003H6908**

The valve will be delivered together with two adapters:
M34 x M45 and M34 x M30

VGS valve ¹⁾

Picture	DN (mm)	k_{vs} (m ³ /h)	Connection	Code No.	
	15	1.0	Cylindrical external thread acc. to ISO 228/1	065B0786	
		1.6		G ¾ A	065B0787
		3.2		G 1 A	065B0788
	20	4.5		G 1 ¼ A	065B0789
	25	6.3		065B0790	

¹⁾ Two adapters are delivered together with the valve: M34 x M45 and M34 x M30 (for details see Accessories); M34 x M45 is factory assembled on the valve.

Ordering (continuous)

Accessories

Picture	Type designation	DN	Connection	Code No.
	Weld-on tailpieces	15	-	003H6908
		20		003H6909
		25		003H6910
	External thread tailpieces	15	Conical ext. thread acc. to EN 10226-1	R 1/2 003H6902
		20		R 3/4 003H6903
		25		R 1 003H6904
	Flange tailpieces	15	Flanges PN 25, acc. to EN 1092-2	003H6915
		20		003H6916
		25		003H6917
	Adapter ¹⁾	M34 × 1.5 mm / M30 × 1.5 mm		003H1835
	Adapter ²⁾	M34 × 1.5 mm / M45 × 1.5 mm		003H6927

¹⁾ Adapter for VGS combinations with electrical actuators type AMV(E) 20, 23, 30, 33.

²⁾ Adapter for VGS combinations with temperature actuators AVT, temperature monitors STM and temperature limiters STL.

Service kits

Picture	Type designation	for valves DN	k _{vs}	Code No.
	Valve body extension with stuffing box	15	3.2	003H6877
		20	4.5	
		25	6.3	

Technical data

Nominal diameter		DN	15			20	25
k _{vs} value	m ³ /h		1.0	1.6	3.2	4.5	6.3
Stroke	mm		3			5	
Control ratio			>1:50				
Control characteristic			linear				
Cavitation factor z			≥ 0.6				≥ 0.55
Leakage acc. to standard IEC 534	% of k _{vs}		≤ 0.05				
Nominal pressure	PN		25				
Max. differential pressure	bar		10				
Medium			Steam / Circulation water / Glycolic water up to 30%				
Medium pH			Min. 7, max. 10				
Medium temperature	°C		2 ... 200				
Connections	valve		External thread				
	tailpieces		Weld-on, external thread and flange				
Materials							
Valve body			Red bronze CuSn5ZnPb (Rg5)				
Valve seat			Stainless steel, mat. No. 1.4571				
Valve cone			Stainless steel, mat. No. 1.4122				
Pressure relive system			Bellows				

Application principles

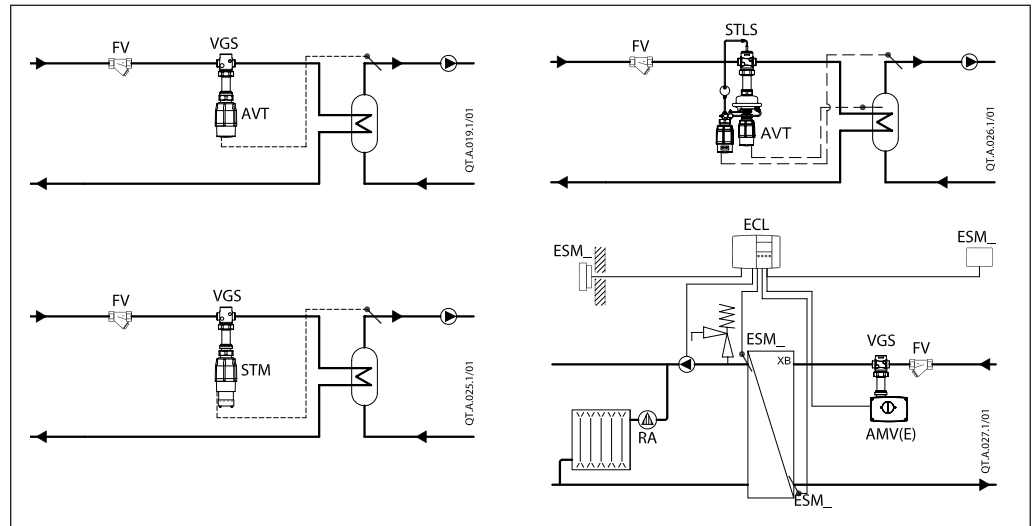

Pressure temperature diagram

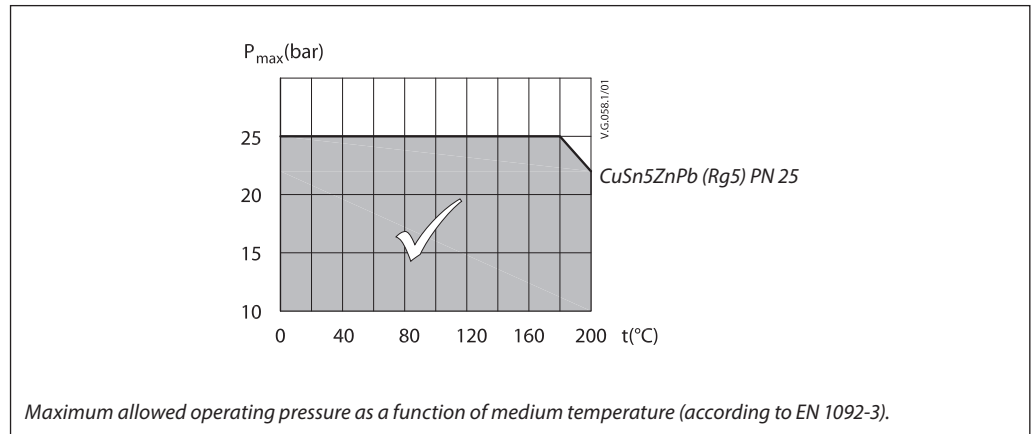

Installation position

Valves can be installed in any position.

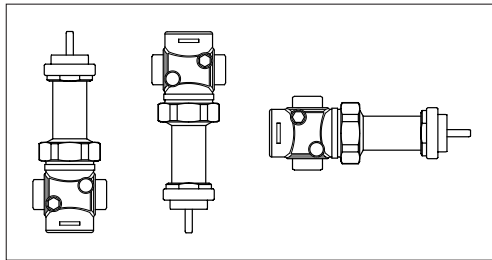

Electrical actuator

Note!
Installation positions for electrical actuators AMV(E) have to be observed as well. Please see relevant Data sheet

Temperature controller and safety temperature monitor

STM / VGS + AVT + adapter M34/M45 (003H6927)

Up to medium temperature of 160 °C temperature controller AVT/VGS and safety temperature monitor STM/VGS can be installed in any position.

For higher temperatures temperature controller AVT/VGS and safety temperature monitor STM/VGS have to be installed horizontal and in horizontal pipes with the actuator oriented downwards.

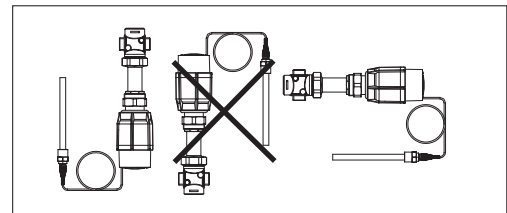
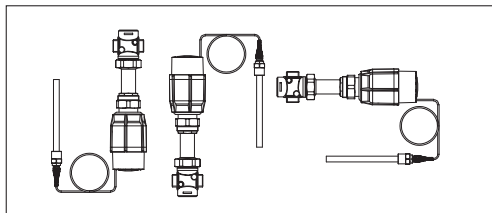

Safety temperature limiter

STL + VGS + adapter M34/M45 (003H6927)

Up to medium temperature of 100 °C safety temperature limiter VGS + STL can be installed in any position.

For higher temperatures safety temperature limiter VGS + STL have to be installed in horizontal pipes only, with a pressure actuator oriented downwards.

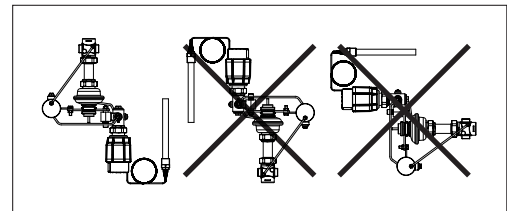
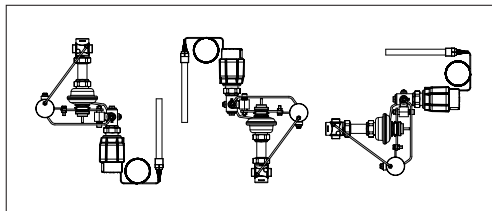

Sizing

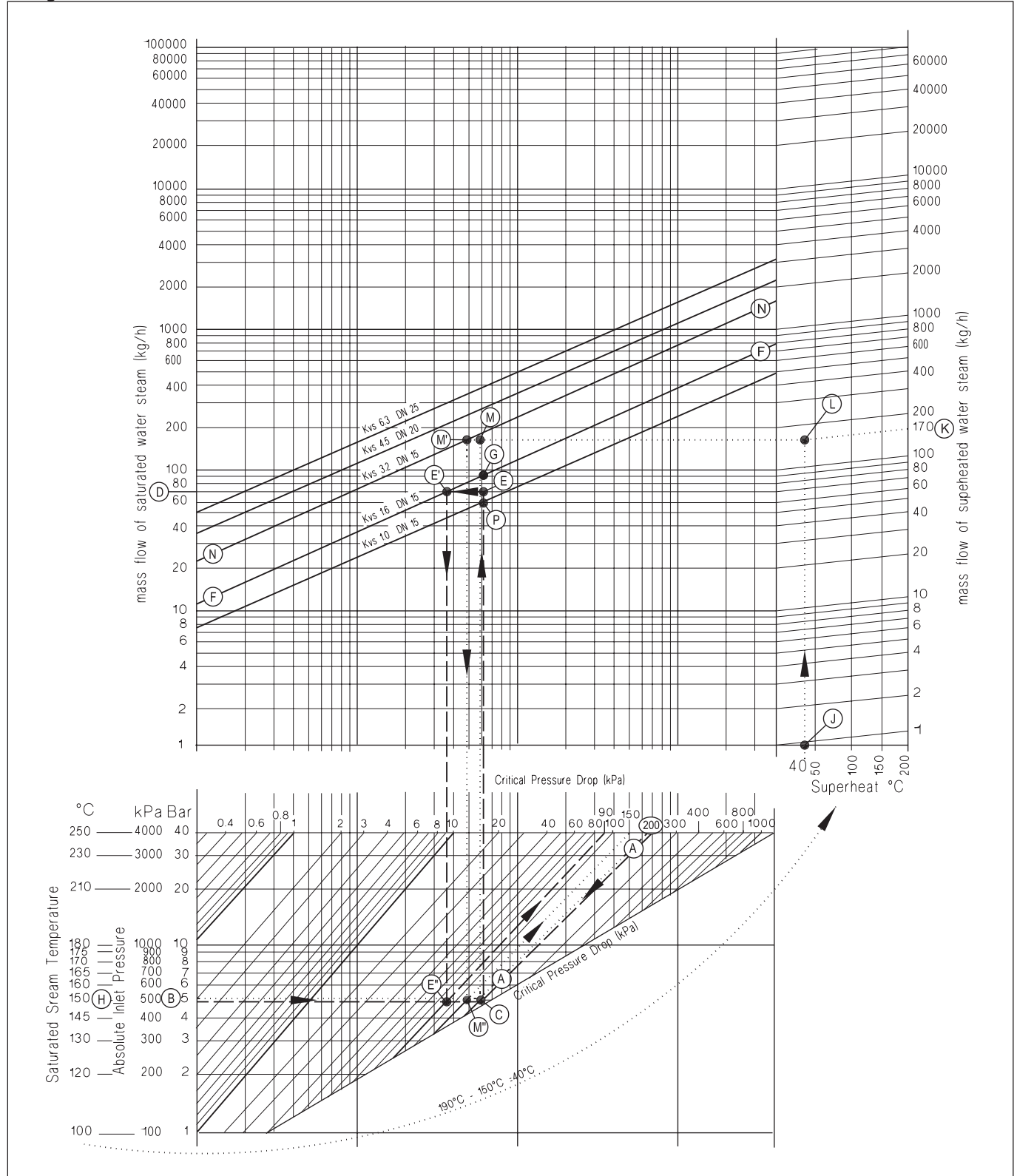

Steam valve sizing is based on 40 % drop of the steam pressure across the valve when fully open. At this condition the steam is travelling at or close to its critical velocity (approx. 300 m/s) and throttling would occur over the full valve stroke.

If the steam is travelling slower than this, then the first part of the valve stroke would merely increase the velocity of the steam without reducing the volumetric flow.

Sizing (continuous)

1. For saturated steam

Given data:

Flow rate: 70 kg/h

Absolute inlet pressure: 5 bar (500 kPa)

Remark:

For this example follow dashed line

The absolute inlet pressure is 500 kPa. Critical pressure drop (40% of 500 kPa) is 200 kPa. Locate the diagonal line corresponding to the pressure drop of 200 kPa (line A-A).

Read the absolute inlet pressure on the lower left hand scale (point B), and draw a horizontal line across until it meets the pressure drop diagonal A-A at point C.

From this point C extend a vertical line upwards until it meets the horizontal line representing the steam flow of 70 kg/h from point D. The intersection of this is point E.

The nearest diagonal k_{vs} line above this is line F-F with a k_{vs} of 1.6. If the ideal valve size is not available the next largest size should be selected to ensure design flow.

The pressure drop through valve at the flow rate is found by the intersection of the 70 kg/h line with F-F (point E') and dropping a vertical line downwards; this actually hits the horizontal line for 500 kPa absolute inlet pressure (point E'') at a pressure drop diagonal of 90 kPa. This is only 18 % of the pressure drop across the valve and the control quality will not be good until the valve has partially closed. As with all steam valves this compromise is necessary since the next smaller valve would not pass the required flow (maximum flow would be about 60 kg/h; point P).

The maximum flow for the same inlet pressure is found by extending the vertical line (C-E) through point E until it crosses the k_{vs} 1.6 line F-F (point G) and reading off the flow (90 kg/h).

2. For superheated steam

Given data:

Flow rate: 170 kg/h

Absolute inlet pressure: 5 bar (500 kPa)

Steam temperature: 190 °C

Remark:

For this example follow dotted line

The procedure for superheated steam is much the same as for saturated steam, but uses a different flow scale which slightly elevates the readings according to the degree of superheat.

As before, the diagonal critical pressure drop line A-A is located at 40 % of 500 kPa (200 kPa). The horizontal inlet pressure line through point B is now extended to the left to read off the corresponding saturated steam temperature at point H (150 °C). The difference between the saturated steam temperature and the superheated steam temperature is 190 °C – 150 °C = 40 °C (see point J).

The superheated steam flow 170 kg/h is found on the upper right hand scale (point K). From here the diagonal line is followed down until it meets a vertical line from the steam temperature elevation (40 °C, point J) at point L.

As before, the horizontal line through point B is drawn to cut line A-A at point C. The point where the vertical line from point C meets the horizontal line from point L is the operating point (point M). This horizontal line, L-M, is the corrected flow line. The nearest diagonal line above this is line N-N with a k_{vs} 3.2. A vertical line dropped from the intersection of L-M line with line N-N (point M') intersects the 500 kPa absolute inlet pressure line (point M'') at a pressure drop diagonal of about 150 kPa. This is about 30% of the pressure drop across the valve which will give reasonable control quality (compared to recommended ratio of 40 %).

Data sheet

2 - way valve for steam, pressure relieved (PN 25)

Design

- 1. Valve body
- 2. Valve insert
- 3. Pressure relieved valve cone
- 4. Valve stem
- 5. Valve body extension
- 6. Stuffing box

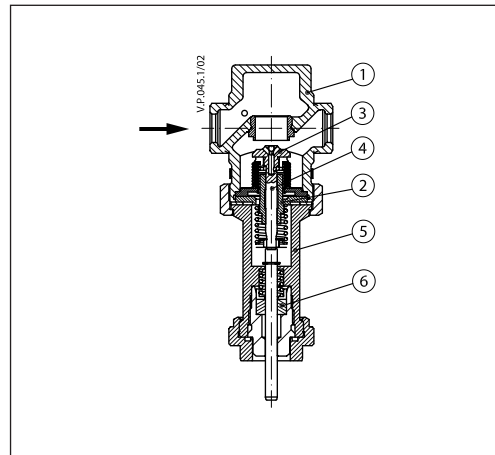

Dimensions

VD.073.2/01

DN			15	20	25
VGS	L	mm	65	70	75
	H		156.5	155	158.5
	Weight	kg	0.7	0.8	0.9

Adapter
M34 x 1.5 mm / M30 x 1.5 mm

Adapter
M34 x 1.5 mm / M45 x 1.5 mm

VD.058.1/01

VD.059.1/01

VD.060.1/01

VD.061.1/01

DN	R ¹⁾	SW	d	L ₁ ²⁾	L ₂	L ₃	k	d ₂	n
15	1/2	32 (G 3/4A)	21	130	120	139	65	14	4
20	3/4	41 (G 1A)	26	150	131	154	75	14	4
25	1	50 (G 1 1/4A)	33	160	145	159	85	14	4

¹⁾ Conical ext. thread acc. to EN 10226-1
²⁾ Flanges PN 25, acc. to EN 1092-2

